

Algebraic Observers to Estimate Unmeasured State Variables of DC Motors

G. Mamani*, J. Becedas*, V. Feliu-Batlle* and H. Sira-Ramírez** †

Abstract—In this article, an original algebraic method is used for the estimation of state variables. The estimation is used to implement a position control scheme for DC motors. In addition, the estimation of the Coulomb's friction coefficient of the servo motor model is also investigated. The approach is based on elementary algebraic manipulations which lead to specific formulae for the unmeasured states. The state estimation algorithm is verified by simulations.

Keywords: State estimation, algebraic identification, DC motors, state observers.

1 INTRODUCTION

Control design methods such as state feedback controls, which use the states in their control laws, are designed under the assumption that all state variables are accessible for measurement. However, in many practical applications to measure all state variables may not be economical or convenient. An alternative approach is to use an estimation technique to provide estimates of that variables which are not measured, based on the available measurements, for its implementation on a feedback control law.

The foundation of linear state estimation was laid by Kalman in [1], Kalman and Bucy in [2], who developed the Kalman filter, which is an efficient recursive filter for linear systems. This processes all available measurements to estimate the current value of the variable of interest by taking into account 1) the system knowledge and measurement device dynamic, 2) the statistical description of the system noises, measurement errors and uncertainty in the dynamics model, and finally 3) any available information about the initial conditions of the variables of interest. Later, Luenberger in [3] and [4] introduced a deterministic version of the Kalman filter, known as Luenberger observer. The theoretical properties of the Kalman filter and the Luenberger observer are well understood and can be found in estimation and system

theory textbooks [5], [6].

It is clear that for an observable system, expressed in state space, the state estimation problem is intimately related to the computation of time derivatives of the output signals, in a sufficient number. The main contribution of this article is that we attempt an algebraic method, of non-asymptotic nature, for the estimation of states, computing a finite number of time derivatives of the system output. The method is based on elementary algebraic manipulations which lead to specific formulae for the unmeasured states. The proposed approach uses the system model, which is known most of times. The estimation method is based on elementary algebraic manipulations of the following mathematical tools: module theory, differential algebra and operational calculus. They were developed in [8]. A differential algebraic justification of this article follows similar lines to those encountered in [9], [10], [11], [12], [13] and [14].

In this work, we use a state estimation method of continuous-time nature for the estimation of unmeasured states of a DC servomotor model to implement a closed loop PD control scheme. After the estimates of the state variables are obtained by the algebraic method proposed, the Coulomb's friction coefficient is instantaneously estimated. The importance of estimating this coefficient and subsequent compensation, in the control scheme, is explained in [7].

This paper is structured as follows: in Section 2, the DC servo motor model and the algebraic state estimation are explained. In Section 3, simulation results verify the correctness of the method; the identification of Coulomb's friction coefficient by using the algebraic state estimator is developed, and the state estimation procedure applied to PD control is also implemented. Finally, Section 4 is devoted to concluding remarks.

2 MOTOR MODEL AND ESTIMATION PROCEDURE

This section is devoted to explain the linear model of the DC motor and the algebraic identification method. We assume that the linear model is affected by unknown perturbation due to the Coulomb's friction effects.

**G. Mamani, J. Becedas and V. Feliu-Batlle are with Universidad de Castilla La Mancha, ETSI Industriales, Av. Camilo José Cela S/N., 13071 Ciudad Real, Spain. glmamani@uclm.es, Jonathan.Becedas@uclm.es, Vicente.Feliu@uclm.es

†**H. Sira-Ramírez is with Cinvestav IPN, Av. IPN, N°2503, nCol. San Pedro Zacatenco AP 14740, 07300 México, D.F., México. hsira@cinvestav.mx

2.1 DC Motor model

A common electromechanical actuator in many control systems is constituted by the DC motor [15]. The DC motor used is supplied by a servo-amplifier with a current inner loop control of the PI type.

The dynamic equation of the system, by using Newton's Second Law, can be expressed as follows:

$$kV = J\ddot{\theta}_m + \nu\dot{\theta}_m + \hat{\Gamma}_c(\dot{\theta}_m) \quad (1)$$

where J is the inertia of the motor [$kg \cdot m^2$], ν is the viscous friction coefficient [$N \cdot m \cdot s$], $\hat{\Gamma}_c$ is the unknown Coulomb friction torque, which affects the motor dynamics [$N \cdot m$]. This nonlinear friction term is considered as a perturbation, depending only on the sign of the angular velocity of the motor, of the form $\mu \text{sign}(\dot{\theta}_m)$, with μ constant. The parameter k is the electromechanical constant of the motor servo-amplifier system [Nm/V]. $\ddot{\theta}_m$ and $\dot{\theta}_m$ are the angular acceleration of the motor [rad/s^2] and the angular velocity of the motor [rad/s] respectively. The constant factor n is the reduction ratio of the motor gear; thus $\theta_m = \hat{\theta}_m/n$, where θ_m stands for the position of the motor gear and $\hat{\theta}_m$ for the position of the motor shaft. $\Gamma_c = \hat{\Gamma}_c n$, where Γ_c is the Coulomb friction torque in the motor gear. V is the motor input voltage [V] acting as the control variable for the system. This is the input to the previously mentioned servo-amplifier, which controls the input current to the motor by means of an internally PI current controller (see Fig.1(a)). This electrical dynamics can be rejected because this is faster than the mechanical dynamics of the motor. Thus, the servo-amplifier can be considered as a constant relation, k_e , between the voltage and the current to the motor: $i_m = uk_e$ (see Fig.1(b)), where i_m is the armature circuit current and k_e includes the gain of the amplifier, \tilde{k} , and the input resistance of the amplifier circuit, R . $V+$ and $V-$, in the pictures, represent the connections which provide the control input voltage u to the servo-amplifier.

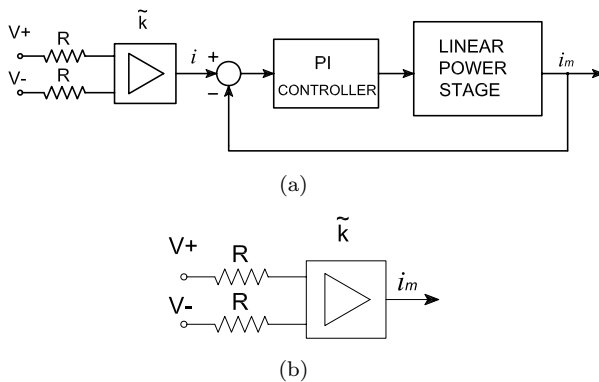

Figure 1: (a) Complete amplifier scheme. (b) Equivalent amplifier scheme.

The total torque given to the motor, Γ_T , is directly proportional to the armature circuit in the form $\Gamma_T = k_m i_m$, where k_m is the electromechanical constant of the motor. Thus, the electromechanical constant of the motor servo-amplifier system is $k = k_e k_m$.

In order to obtain the transfer function of the system, the following perturbation-free system is considered:

$$KV = J\ddot{\theta}_m + \nu\dot{\theta}_m \quad (2)$$

where $K = k/n$. To simplify the developments, let $A = K/J$, $B = \nu/J$. The DC motor transfer function is then written as:

$$G(s) = \frac{\theta_m(s)}{V(s)} = \frac{\frac{K}{J}}{s^2 + \frac{\nu}{J}s} = \frac{A}{s(s+B)} \quad (3)$$

2.2 The procedure of state estimation

Consider the second order perturbed system given in (1). By taking this into account, and also the fact that $K = k/n$, the following expression is obtained after some rearrangements:

$$\ddot{\theta}_m + B\dot{\theta}_m + \Gamma^* = AV \quad (4)$$

where $\Gamma^* = \frac{\hat{\Gamma}_c}{nJ}$. This parameter is considered as a constant perturbation input and this will be identified in a next stage.

We proceed to compute the unmeasured states: the motor velocity, $\frac{d\theta_m}{dt}$, and the motor acceleration, $\frac{d^2\theta_m}{dt^2}$.

Taking Laplace transforms of (4) yields

$$\begin{aligned} (s^2\theta_m(s) - s\theta_m(0) - \dot{\theta}_m(0)) + \\ + B(s\theta_m(s) - \theta_m(0)) + \frac{\Gamma^*}{s} = AV(s) \end{aligned} \quad (5)$$

by multiplying out by s , the following expression is obtained:

$$\begin{aligned} (s^3\theta_m(s) - s^2\theta_m(0) - s\dot{\theta}_m(0)) + \\ + B(s^2\theta_m(s) - s\theta_m(0)) + \Gamma^* = AsV(s) \end{aligned} \quad (6)$$

Taking the third derivative with respect to the complex variable s , independence of initial conditions is obtained. Thus, (6) results in an expression free of the initial conditions $\theta_m(0)$, $\dot{\theta}_m(0)$ and Coulomb's friction coefficient Γ^* :

$$\frac{d^3}{ds^3} [s^3\theta_m(s)] + B\frac{d^3}{ds^3} [s^2\theta_m(s)] = A\frac{d^3}{ds^3} [sV(s)] \quad (7)$$

The terms of (7) are developed as

$$\frac{d^3}{ds^3} [s^3\theta_m(s)] = s^3 \frac{d^3\theta_m(s)}{ds^3} + 9s^2 \frac{d^2\theta_m(s)}{ds^2} + \quad (8)$$

$$+ 18s \frac{d\theta_m(s)}{ds} + 6\theta_m(s)$$

$$\frac{d^3}{ds^3} [s^2\theta_m(s)] = s^2 \frac{d^3\theta_m(s)}{ds^3} + 6s \frac{d^2\theta_m(s)}{ds^2} + 6 \frac{d\theta_m(s)}{ds} \quad (9)$$

$$\frac{d^3}{ds^3} [sV(s)] = s \frac{d^3V(s)}{ds^3} + 3 \frac{d^2V(s)}{ds^2} \quad (10)$$

Recall that multiplication by s in the operational domain corresponds to derivation in the time domain. After replacing the expressions (8, 9, 10) in equation (7), both sides of the resulting expression are multiplied by s^{-2} . The following equation is obtained:

$$s \frac{d^3\theta_m(s)}{ds^3} + 9 \frac{d^2\theta_m(s)}{ds^2} + 18s^{-1} \frac{d\theta_m(s)}{ds} + 6s^{-2}\theta_m(s) \quad (11)$$

$$+ B \left(\frac{d^3\theta_m(s)}{ds^3} + 6s^{-1} \frac{d^2\theta_m(s)}{ds^2} + 6s^{-2} \frac{d\theta_m(s)}{ds} \right) =$$

$$A \left(s^{-1} \frac{d^3V(s)}{ds^3} + 3s^{-2} \frac{d^2V(s)}{ds^2} \right)$$

In the time domain, this is expressed as

$$-\frac{d}{dt}(t^3\theta_m) + 9t^2\theta_m - 18 \int_0^t \sigma\theta_m(\sigma)d\sigma$$

$$+ 6 \int_0^t \int_0^\sigma \theta_m(\lambda)d\lambda d\sigma + B((-t^3\theta_m)$$

$$+ 6 \int_0^t \sigma^2\theta_m(\sigma)d\sigma - 6 \int_0^t \int_0^\sigma \lambda\theta_m(\lambda)d\lambda d\sigma)$$

$$= A \left(- \int_0^t \sigma^3V(\sigma)d\sigma + 3 \int_0^t \int_0^\sigma \lambda^2\theta_m(\lambda)d\lambda d\sigma \right) \quad (12)$$

Hence, the estimation of the motor velocity is

$$\frac{d\theta_m}{dt} = \frac{1}{t^3}(6t^2\theta_m - 18 \int_0^t \sigma\theta_m(\sigma)d\sigma$$

$$+ 6 \int_0^t \int_0^\sigma \theta_m(\lambda)d\lambda d\sigma) + \frac{1}{t^3}(-Bt^3\theta_m +$$

$$6B \int_0^t \sigma^2\theta_m(\sigma)d\sigma - 6B \int_0^t \int_0^\sigma \lambda\theta_m(\lambda)d\lambda d\sigma)$$

$$+ \frac{1}{t^3}(A \int_0^t \sigma^3V(\sigma)d\sigma - 3A \int_0^t \int_0^\sigma \lambda^2\theta_m(\lambda)d\lambda d\sigma) \quad (13)$$

After replacing the expressions (8, 9, 10) in equation (7), both sides of the resulting expression are multiplied by s^{-1} to obtain the following expression:

$$(s^2 \frac{d^3\theta_m(s)}{ds^3} + 9s \frac{d^2\theta_m(s)}{ds^2} + 18 \frac{d\theta_m(s)}{ds} + 6s^{-1}\theta_m(s))$$

$$+ B \left(s \frac{d^3\theta_m(s)}{ds^3} + 6 \frac{d^2\theta_m(s)}{ds^2} + 6s^{-1} \frac{d\theta_m(s)}{ds} \right)$$

$$= A \left(\frac{d^3V(s)}{ds^3} + 3s^{-1} \frac{d^2V(s)}{ds^2} \right) \quad (14)$$

which may be written in the time domain as

$$-\frac{d^2}{dt^2}(t^3\theta_m) + 9 \frac{d}{dt}(t^2\theta_m) - 18t\theta_m + 6 \int_0^t \theta_m(\sigma)d\sigma$$

$$+ B \left(\frac{d}{dt}(-t^3\theta_m) + 6t^2\theta_m - 6 \int_0^t \sigma\theta_m(\sigma)d\sigma \right) - At^3V$$

$$+ 3A \int_0^t \sigma^2\theta_m(\lambda)d\sigma$$

And the following expression for the motor acceleration, $\frac{d^2\theta_m}{dt^2}$, is obtained:

$$\frac{d^2\theta_m}{dt^2} = \frac{1}{t^3}(3t^2 \frac{d\theta_m}{dt} - 6t\theta_m + 6 \int_0^t \theta_m(\sigma)d\sigma + 3Bt^2\theta_m)$$

$$+ \frac{1}{t^3}(-Bt^3 \frac{d\theta_m}{dt} - 6B \int_0^t \sigma\theta_m(\sigma)d\sigma + At^3V$$

$$- 3A \int_0^t \sigma^2\theta_m(\lambda)d\sigma) \quad (15)$$

This expression may now be evaluated with the help of the already computed estimate of $\frac{d\theta_m}{dt}$.

The practise real time implementation of the velocity and acceleration observers can also be carried out by computation of properly time-varying linear, unstable, Brunovsky filters. For the velocity observer:

$$\dot{\theta}_m = \frac{6}{t}\theta_m - B\theta_m + x_1$$

$$\dot{x}_1 = -\frac{18}{t^2}\theta_m + \frac{6B}{t}\theta_m + AV + x_2$$

$$\dot{x}_2 = \frac{6}{t^3}\theta_m - \frac{6B}{t^2}\theta_m - \frac{3A}{t}\theta_m \quad (16)$$

For the acceleration observer:

$$\ddot{\theta}_m = \left[\frac{3}{t} - B \right] \dot{\theta}_m + \frac{3B}{t}\theta_m + AV + y_1$$

$$\dot{y}_1 = \frac{6}{t^3}\theta_m - \frac{6B}{t^2}\theta_m - \frac{3A}{t}\theta_m \quad (17)$$

3 SIMULATIONS

This section is devoted to show the good performance of the proposed state estimation method. The values of the motor parameters used in simulations are depicted in Table 1. The differential equation of the closed loop system is solved by using a $1 \cdot 10^{-3}$ [s] fixed step fifth order Dormand Prince method to emulate real-time experiments, where the data is obtained every time instant with an acquisition card. We consider that there exists

Table 1: Parameters of the DC motor used in the simulations

A	B	k	n	μ
61.13	15.15	0.21	50	34.74

a servo-amplifier which is used to supply voltage to the DC motor. This amplifier accepts control inputs from the computer in the range of $[-10, 10]$ [V].

The signals used for the on-line estimation of the motor velocity are the input voltage to the DC motor and the motor position as a result of that input. In this case, we chose the input to be a Bezier's eighth order polynomial with an offset of 0.8 (V). Thus, we consider the following initial conditions for the motor to show the robustness of the method with respect to initial conditions: $\theta_m(0) = 100$, $\dot{\theta}_m(0) = 0$. Both signals are depicted in Fig.2(a) and Fig.2(b) respectively.

The results are compared with the numerical derivative used in *Simulink* of *Matlab*. Fig.3(a) depicts the output of the velocity motor observer represented by $\frac{d\theta_t}{dt}$. We can compare it with that of the Simulink numerical block here represented by $\frac{d\theta_{tn}}{dt}$. Note that the two signals are superimposed. The difference between them is depicted in Fig.3(b) and this is with 10^{-3} order. In Fig.3(c) the estimation of the motor acceleration $\frac{d^2\theta_t}{dt^2}$ is depicted, and also the numerical estimation $\frac{d^2\theta_{tn}}{dt^2}$. The difference $\frac{d^2\theta_t}{dt^2} - \frac{d^2\theta_{tn}}{dt^2}$ between them is depicted in Fig.3(d). Now, the difference is more noticeable because the first derivative of the signal is required to obtain the second one, and in the case of the numerical estimation not knowledge of the system is used. This is the reason because the difference increases. Furthermore, the observer proposed takes all the information of the system as possible providing more exact estimations. This premise is demonstrated in the application of Coulomb's friction estimation, where more accurate state estimation provides better parameter estimation.

In the new simulations, robustness with respect noise of the algebraic state estimation is demonstrated. We consider noise in the measure (i.e in the motor position measure) with zero mean and $1 \cdot 10^{-3}$ standard deviation.

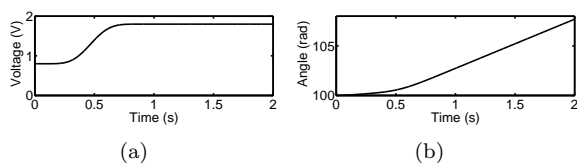
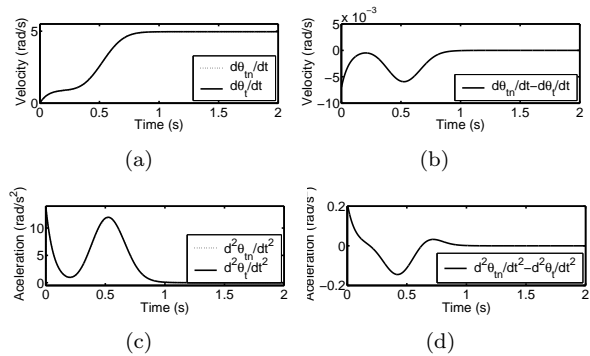

Figure 2: Input and response of the motor. (a) Input to the DC motor. (b) Response of the DC motor.

 Figure 3: Comparison between the estimations of the velocity and acceleration of the DC motor with the numerical method and with the algebraic state estimation. (a) Velocities estimation. (b) Difference between the two velocity estimations, $\theta_{tn} - \theta_t$. (c) Accelerations estimation. (d) Difference between the two acceleration estimations, $\theta_{tn} - \theta_t$.

When noise appears in a measure, numerical estimation of the signal derivatives is very imprecise and the estimation of bounded derivatives amplify the noise level. These signals are, customarily, quite noisy and the use of low pass filters become necessary to smooth them, causing the well known dynamic delays which affect the performance of the obtained signals as a result. A solution to this problems may be the use of the algebraic state estimator, which present robustness with respect to the noise. In Fig.4(a) the numerical estimation of the motor velocity is depicted. The effect that the noise produces in the estimation is obvious. Fig.4(b) depicts the velocity estimation with the algebraic state estimator. In Fig.4(c) the second derivative of the motor position is represented. Note that the noise level has been increased in this signal. Finally, Fig.4(d) depicts the second derivative of the motor estimated with the algebraic state estimator. Let us recall that filters have not been used in the estimations.

An scheme of the observers implementation is depicted in Fig.5.

This technique may be used in many applications such as estimation of parameters in which estimation of states are required, and control of a feedback system because the estimators can be used in both open and closed loop due to the method does not require dependence between the system input and output.

3.1 Estimation application

From the 1990's decade has existed an increasing interest in controlling systems with gear reduction coupled in the motor shaft. Researchers had to deal with non linearities which strongly affect the motor dynamics and which were produced by the friction torque [7]. In order to solve that problem, researchers used many techniques such as

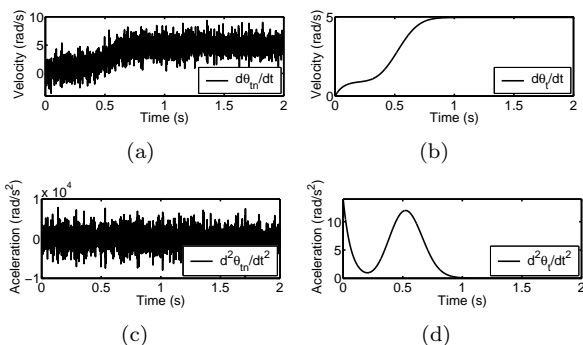

Figure 4: Velocity estimations. (a) Numerical velocity estimation. (b) Algebraic velocity estimation. (c) Numerical acceleration estimation. (d) Algebraic acceleration estimation.

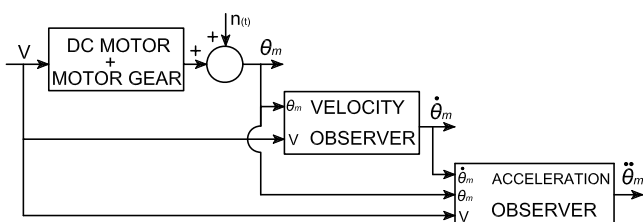

Figure 5: Scheme of the algebraic observers implementation

robust control schemes with high gain that minimized this effect [17] or the most modern techniques such as neural networks [16] which delay the obtaining of the non linearity parameters. We here propose a new and precise technique to obtain such parameters by using algebraic state estimators, which can be used in real time and in continuous time without the use of any sort of filter.

It is well established that for a system operating at relatively high speed, the Coulomb's friction torque is a function of the angular velocity. For those systems, the Coulomb's friction is often expressed as a signum function dependent on the rotational speed [9], [10].

Consider system (4) with $\Gamma^* = \mu \text{sign}(\dot{\theta}_m)$. From this equation, and due to the fact that the angular velocity and acceleration of the motor are obtained with the fast state estimation method, and that A and B are known, we have

$$\mu \text{sign} \dot{\theta}_m = AV - (\ddot{\theta}_m)_e - B(\dot{\theta}_m)_e \quad (18)$$

The term: $\mu \text{sign}(\dot{\theta}_m)$ is a perturbation produced by the Coulomb's friction torque, where μ is the scaled Coulomb's friction amplitude, or coefficient¹. The model

¹Note that $\Gamma^* = \frac{\hat{\tau}_c}{nJ} = \mu \text{sign}(\dot{\theta}_m)$ then, the Coulomb's friction coefficient is $\xi = Jn\mu$.

$\text{sign}(\dot{\theta}_m)$ is defined as follows:

$$\text{sign}(\dot{\theta}_m) = \begin{cases} 1 & (\dot{\theta}_m > 0), \\ -1 & (\dot{\theta}_m < 0) \end{cases} \quad (19)$$

With the motor spinning only in one direction, Coulomb's friction coefficient will not change its sign, and can be considered as a constant. When the motor angular velocity is close to zero, the Coulomb's friction effect is that of a chattering high frequency signal.

$$\Gamma^* = \mu \text{sign}(V) = \begin{cases} \mu & (V > 0), \\ -\mu & (V < 0) \end{cases} \quad (20)$$

Then, if the motor always spins in the same direction, in the identification time interval, we have $\Gamma^* = \mu$ and

$$\mu = AV - (\ddot{\theta}_m)_e - B(\dot{\theta}_m)_e \quad (21)$$

Fig.6(a) shows the estimation of the Coulomb's friction coefficient by using numerical state estimation (μ_n signal) and by using algebraic state estimation (μ_s signal). Note that the estimation μ_s is obtained from the beginning, at time $t \approx 0$, and this value is maintained while the estimator works. Nevertheless, the estimation μ_n which uses numerical state estimations introduce an error until $t = 1$ (s), time at which the Bezier's trajectory finishes. The error of the two estimates with respect the real value of the Coulomb's parameter μ is depicted in Fig.6(b). Note that the error in the estimation with the algebraic state estimators is null. This is because the state estimation with the proposed method provides an exact estimation of the bounded derivatives of the motor position due to the estimator uses all the information as possible from the system to estimate.

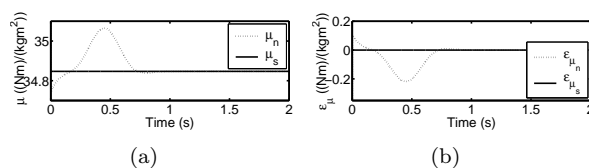

Figure 6: Coulomb's friction coefficient estimation. (a) Estimation of the Coulomb's friction coefficient. (b) Estimation error.

Fig.7(a) to Fig.7(c) depict the results obtained in the Coulomb's parameter estimation with a noise in the measure of the motor position with zero mean and 10^{-3} standard deviation, as done in the previous simulations. In Fig.7(a) the estimation with numerical estimations of the states is depicted. Note that to identify any value in such a figure is impossible. However, Fig.7(b) depicts an accurate estimation of the parameter estimated by using the algebraic method. The error of this last estimation is shown in Fig.7(c).

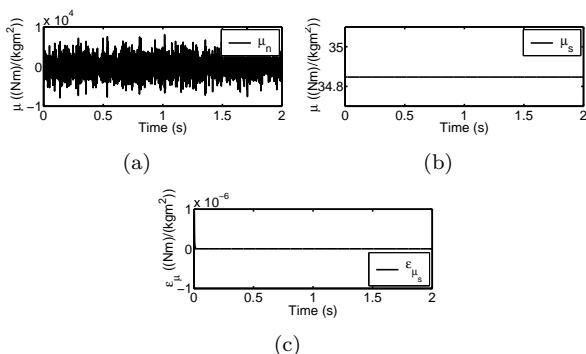

Figure 7: Coulomb's friction coefficient estimation. (a) Numerical estimation. (b) Algebraic estimation. (c) Algebraic estimation error.

3.2 Control application

DC motor is a topic of interest since this is used as actuator in an extensive variety of robotics systems and one of the most used control methods is that based on proportional derivative *PD* controller. [18] and [19] are examples of this. The inconvenient of this sort of control is the computation of the derivative action which always introduce noises in the control voltage input due to the on-line estimation of the input derivative to the controller. Sometimes filters are required to smooth that signal. In this subsection a control application for DC motors is proposed, based on the on-line algebraic estimation of the motor velocity.

A PD controller is proposed, $C_{pd}(s) = k_p + k_v s$, whose gains $\{k_p, k_v\}$ can be designed by locating all the poles in closed loop of the complete system (See Fig.8) in the same location of the negative real axis.

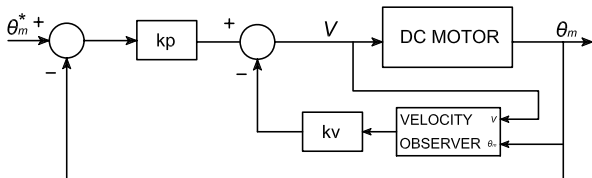

Figure 8: Closed loop PD controller with algebraic observer implementation

The stability condition on the closed loop expression $(1 + G_{m0}(s)C_{pd}(s))$ leads to the following characteristic polynomial,

$$s^2 + (k_v A + B)s + k_p A = 0 \quad (22)$$

We can equate the corresponding coefficients of the closed loop characteristic polynomial (22) with those of a desired second order Hurwitz polynomial. Thus, we can choose to place all the closed loop poles at some real value using

the following desired polynomial expression,

$$p(s) = (s + a)^2 = s^2 + 2as + a^2 \quad (23)$$

where the parameter a , strictly positive, represents the common location of all the closed loop poles. Identifying the corresponding terms of the equations (22) and (23) the parameters k_p and k_v may be uniquely obtained by computing the following equations,

$$k_p = \frac{a^2}{A} \quad (24)$$

$$k_v = \frac{2a - B}{A} \quad (25)$$

With the previous estimation of the Coulomb's friction torque, Γ_c , a compensation term is introduced in the system to eliminate the effect of this perturbation [7]. The compensation term is included in the control input voltage to the motor, and this is of the following form:

$$\tilde{\Gamma} = \frac{\hat{\Gamma}_c}{k} (-sign(\dot{\theta}_m)) = \frac{\mu \cdot J \cdot n}{k} (-sign(\dot{\theta}_m)) \quad (26)$$

when $\dot{\theta}_m \neq 0$. The function $sign(V)$ is the same as that defined in (19). When $\dot{\theta}_m \approx 0$, the compensation term is included as:

$$\tilde{\Gamma} = \frac{\hat{\Gamma}_c}{k} (-sign(V)) = \frac{\mu \cdot J \cdot n}{k} (-sign(V)) \quad (27)$$

The function $sign(V)$ is the same as that defined in (20).

Fig.9 depicts the trajectory tracking of the motor with the PD controller with numerical computation of the motor velocity θ_{tn} and with the algebraic computation θ_t . The two signals properly track the reference trajectory θ_t^* with good performance.

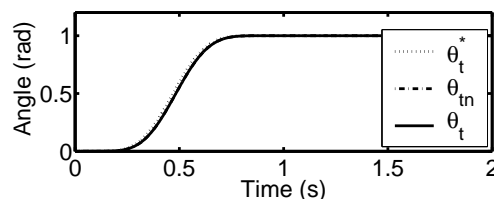

Figure 9: Trajectory tracking of the closed loop system. θ_t^* , reference. θ_{tn} , response with numerical PD. θ_t response with algebraic PD.

In Fig.10(a) the tracking error of the motor position, when numerical PD is used, is presented. By comparing such an error with that of the Fig.10(b), in which the tracking error of the motor position with algebraic PD is depicted, we can observe that the two signals are the same in phase and magnitude. And we can observe the same characteristic in Fig.11(a) and Fig.11(b), where the control input voltages to the DC motor are depicted. This accurate tracking of both control schemes is due to the

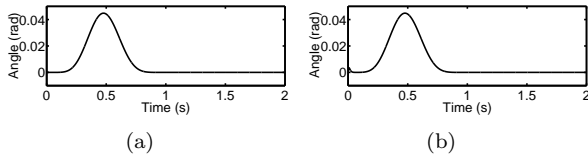

Figure 10: Tracking errors. (a) Tracking error with numerical implementation. (b) Tracking error with algebraic implementation.

gains of the controllers, which force the system to track the command trajectory by minimizing the error in the feedback. However, in real life we always find noises and errors which corrupt the measuring data. In this case, the encoder is not an infinite precisely measure system, therefore, noises are included in the control system due to the limited precision of the apparatus.

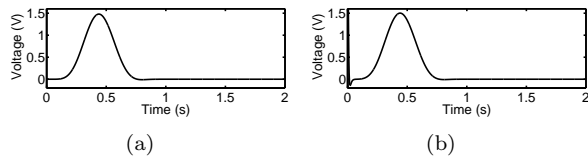

Figure 11: Control input voltages to the DC motor. (a) Input voltage with numerical implementation. (b) Input voltage with algebraic implementation.

We consider a noise corrupting the data with zero mean and 10^{-3} standard deviation, as considered in the previous simulations. Fig.12 depicts the trajectory tracking of the motor position with numerical PD, θ_{tn} , and with algebraic PD, θ_t . Both trajectories properly follow the reference θ_t^* . Fig.13(a) and Fig.13(b) depict the tracking errors of the previous signals respectively. Note that the noise is introducing an aleatory component in the error. Although the two errors have the same amplitude, the control input voltage to the DC motor of the numerical PD has not a smooth shape. Nevertheless, such a voltage would saturate the amplifier, which has the limits in ± 10 (V) (see Fig.14(a)). In contrast, the control input voltage, when algebraic PD is used, has a smoother profile with much less control effort, therefore, such a signal would never saturate the amplifier. As a consequence, the amplifier would not suffer overheating (see Fig.14(b)).

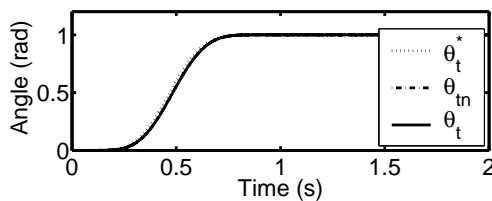

Figure 12: Trajectory tracking of the closed loop system. θ_t^* , reference. θ_{tn} , response with numerical PD. θ_t , response with algebraic PD.

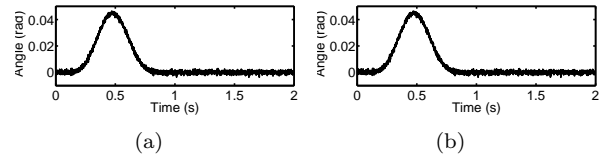

Figure 13: Tracking errors. (a) Tracking error with numerical implementation. (b) Tracking error with algebraic implementation.

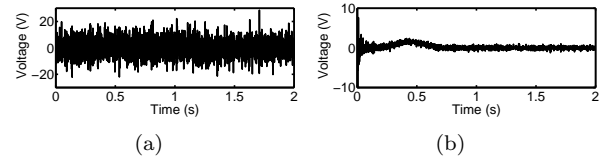

Figure 14: Control input voltages to the DC motor. (a) Input voltage with numerical implementation. (b) Input voltage with algebraic implementation.

4 SUMMARY AND CONCLUSIONS

The state estimation method using the algebraic method proposed, based on module theory, differential algebra and operational calculus, has accurately performed on a DC motor model. The methodology only requires the measurement of the motor angular position and input voltage.

The method has been successfully applied to estimate the Coulomb's friction coefficient. Performance studies show that the algebraic method provides satisfactory estimates even in the presence of significant noise levels. In addition, the state feedback controller is designed. Closed-loop simulation runs show that the state estimates obtained by the proposed method can be used efficiently.

Among the advantages of this approach we find that *i*) this is independent of the motor initial conditions; *ii*) the methodology is robust with respect to the Coulomb's friction torque, considered as a constant perturbation input; *iii*) this is also robust with respect to zero mean high frequency noises; *iv*) a direct estimation of the states is achieved without translation between discrete and continuous time domain, which usually provides an erroneous information of the system dynamics; and finally, *v*) the approach does not require a specific design of the inputs to the system.

The results obtained with the method demonstrate an accurate performance, and can be successfully used in regulated closed loop systems.

5 ACKNOWLEDGMENTS

This research was supported by the Spanish Government, Ministerio de Educación y Ciencia, via project

Ref.:DPI2006-13834, by the Junta de Comunidades de Castilla-La Mancha, Spain, via Project PBI-05-057 and by the European Social Fund.

References

- [1] R. Kalman, "A new approach to linear filtering and prediction problems", *Transactions of the ASME, Journal of Basic Engineering*, 1960; 83: 95–108.
- [2] R. Kalman, "New results in linear filtering and prediction theory", *Transactions of the ASME, Journal of Basic Engineering*, 1960; 82: 35–45. luenberger
- [3] D. G. Luenberger, "Observing the state of a linear system", *IEEE Transactions on Military Electronic*, 1964; 8: 74–80.
- [4] D. G. Luenberger, "An introduction to observers", *IEEE Transactions on Automatic Control*, 1971; AC-16: 596-602.
- [5] B. Friedland, *Control system design- an introduction to state space methods*, New York: McGraw-Hill, 1986.
- [6] C. T. Chen, *Linear system theory and design*, New York: Holt, Rinchart and Winston, 1984.
- [7] H. Olsson, K. Amström and C.C. de Wit, "Friction models and Friction Compensation", *European Journal of Control.*, Vol. 4, 1998, pp. 176-195.
- [8] M. Fliess and H. Sira-Ramírez, "An algebraic framework for linear identification", in *ESAIM: Control, Optimisation and Calculus of Variations*, vol. 9, 2003, pp. 151-168.
- [9] M. Fliess and H. Sira-Ramírez, "On the non-calibrated visual based control of planar manipulators: An on-line algebraic identification approach", in *IEEE-SMC-2002*, vol. 5, 2002.
- [10] H. Sira-Ramírez, E. Fossas and M. Fliess, "Output trajectory tracking in an uncertain double bridge buck dc to dc power converter: An algebraic on-line parameter identification approach", in *Proc. 41 st IEEE Conference on Decision and Control*, vol. 3, 2002, pp. 2462-2467.
- [11] H. Sira-Ramírez and M. Fliess, "On the discrete time uncertain visual based control of planar manipulator: An on-line algebraic identification approach", in *Proc. 41 st IEEE Conference on Decision and Control*, 2002.
- [12] M. Fliess, M. Mboup, H. Mounier, and H. Sira-Ramírez, *Questioning some paradigms of signal processing via concrete example*, Editorial Lagares, Mexico City, 2003.
- [13] G. Mamani, J. Becedas, H. Sira-Ramírez and V. Feliu-Batlle, "Open-loop algebraic Identification method for DC motor", *2007 European Control Conference*, Greece, (2007).
- [14] J. Becedas, J.R. Trapero, G. Mamani, H. Sira-Ramírez, V. Feliu-Batlle, "A fast on-line algebraic estimation of a single-link flexible arm applied to GPI control", *The 32nd Annual Conference of the IEEE Industrial Electronics Society*, Paris, France, (2006).
- [15] R. D. Begamudre, "Flectro-Mechanical Energy Conversion with Dynamic of Machines," in *Wiley New York*, 1998.
- [16] S. Cicero, V. Santos and B. de Carvahlo, "Active control to flexible manipulators", *IEEE/ASME Transactions on Mechatronics*, Vol. 11, N. 1, pp. 75–83, (2006).
- [17] V. Feliu and K. S. Rattan and H. B. Brown, "Control of flexible arms with friction in the joints", *IEEE Transactions on Robotics and Automation*, Vol.9, N.4, pp.467–475 (1993)
- [18] C. Rivetta and C. Briegel and P. Czarapata, "Motion control design of the SDSS 2.5 mts telescope" *Proceedings of SPIE*, pp.212–221. (2000)
- [19] V. Feliu and F. Ramos, "Straing gauge based control of single-link flexible very light weight robots robust to payload changes", *Mechatronics*, Vol.15, pp.547–571,(2005)